

EOM

ENGINEERING OPERATION
& MAINTENANCE

PS2

Saniflo™ Hygienic Series Metal Pumps



Where Innovation Flows

WILDEN®

WIL-12330-E-08

Contents

Section 1: Precautions - Read First!	4
Section 2: Wilden Pump Designation System	5
Section 3: How It Works	6
Section 4: Dimensional Drawings	7
Section 5: Performance	8
PS2 Saniflo HS Rubber-Fitted.....	8
PS2 Saniflo HS Full-Stroke TPE Integral Piston Diaphragm-Fitted.....	8
PS2 Saniflo HS Full-Stroke TPE-Fitted.....	9
PS2 Saniflo HS Full-Stroke PTFE- Fitted.....	9
Suction-Lift Curves.....	10
Section 6: Suggested Installation, Operation, Maintenance and Troubleshooting	11
Section 7: Disassembly / Reassembly	14
Pump Disassembly.....	14
Wil-Gard™ Diaphragm Sensor.....	17
Swivel Pump Stand Option.....	18
Air Valve / Center Section Disassembly.....	19
Single-Point Exhaust.....	22
Reassembly Hints & Tips.....	22
Section 8: Clean-In-Place - CIP	24
Section 9: Exploded View and Parts List	25
PS2 Saniflo HS.....	25
PS2 Saniflo HS 1935/2004/EC.....	28
Section 9: Elastomer Options	31

Copyright

Copyright 2018 PSG®, a Dover Company. All rights reserved.

PSG reserves the right to modify the information and illustrations in this document without prior notice. The product described in this document is furnished under a license agreement or nondisclosure agreement. No part of this document may be reproduced, stored in a retrieval system, or transmitted in any form or any means electronic or mechanical, including photocopying and recording, without the written permission of PSG, a Dover Company, except as described by the terms of those agreements.

This is a non-contractual document. 01-2019.

Trademarks

PSG and the PSG logo are registered trademarks of PSG. Wilden® is a registered trademark of PSG California LLC. Pro-Flo® SHIFT and Pro-Flo® are registered trademarks of PSG California LLC. Wil-Flex® is a trademark of PSG California LLC. Saniflex™ is a trademark of PSG California LLC.

All trademarks, names, logos and service marks (collectively "trademarks") in this document are registered and unregistered trademarks of their respective owners. Nothing contained in this document should be construed as granting any license or right to use any trademark without the prior written permission of the trademark owner.

Warranty

Each and every product manufactured by Wilden is built to meet the highest standards of quality. Every pump is functionally tested to insure integrity of operation. Wilden warrants that pumps, accessories and parts manufactured or supplied by it to be free from defects in material and workmanship for a period of five (5) years from date of installation or six (6) years from date of manufacture, whichever comes first.

For more information, and to register your Wilden pump for warranty, please visit <https://www.psgdover.com/wilden/support/warranty-registration>.

Certifications



Section 1

Precautions - Read First!

 **CAUTION:** Do not apply compressed air to the exhaust port — pump will not function.

 **CAUTION:** Do not over-lubricate air supply — excess lubrication will reduce pump performance. Pump is pre-lubed.

 **TEMPERATURE LIMITS:**

Acetal	-29°C to 82°C	-20°F to 180°F
Buna-N	-12°C to 82°C	10°F to 180°F
Geolast®	-40°C to 82°C	-40°F to 180°F
Neoprene	-18°C to 93°C	0°F to 200°F
Nordel® EPDM	-51°C to 138°C	-60°F to 280°F
Nylon	-18°C to 93°C	0°F to 200°F
PFA	-7°C to 107°C	45°F to 225°F
Polypropylene	0°C to 79°C	32°F to 175°F
Polyurethane	-12°C to 66°C	10°F to 150°F
PVDF	-12°C to 107°C	10°F to 225°F
Saniflex™	-29°C to 104°C	-20°F to 220°F
SIPD PTFE with EPDM-backed	4°C to 137°C	40°F to 280°F
SIPD PTFE with Neoprene-backed	4°C to 93°C	40°F to 200°F
PTFE ¹	4°C to 104°C	40°F to 220°F
FKM	-40°C to 177°C	-40°F to 350°F
Wil-Flex™	-40°C to 107°C	-40°F to 225°F

¹4°C to 149°C (40°F to 300°F) - 13 mm (1/2") and 25 mm (1") models only.

NOTE: Not all materials are available for all models. Refer to Section 2 for material options for your pump.

 **CAUTION:** When choosing pump materials, be sure to check the temperature limits for all wetted components. Example: FKM has a maximum limit of 177°C (350°F) but polypropylene has a maximum limit of only 79°C (175°F).

 **CAUTION:** Maximum temperature limits are based upon mechanical stress only. Certain chemicals will significantly reduce maximum safe operating temperatures. Consult Chemical Resistance Guide for chemical compatibility and temperature limits.

 **WARNING:** Prevent static sparking. If static sparking occurs, fire or explosion could result. Pump, valves and containers must be grounded to a proper grounding point when handling flammable fluids and whenever discharge of static electricity is a hazard.

 **CAUTION:** Do not exceed 8.6 bar (125 psig) air supply pressure.

 **CAUTION:** The process fluid and cleaning fluids must be chemically compatible with all wetted pump components. Consult Chemical Resistance Guide.

 **CAUTION:** Do not exceed 82°C (180°F) air inlet temperature for all models.

 **CAUTION:** Pumps should be thoroughly flushed before installing into process lines. FDA- and USDA-approved pumps should be cleaned and/ or sanitized before being used.

 **CAUTION:** Always wear safety glasses when operating pump. If diaphragm rupture occurs, material being pumped may be forced out air exhaust.

 **CAUTION:** Before any maintenance or repair is attempted, the compressed air line to the pump should be disconnected and all air pressure allowed to bleed from pump. Disconnect all intake, discharge and air lines. Drain the pump by turning it upside down and allowing any fluid to flow into a suitable container.

 **CAUTION:** Blow out air line for 10 to 20 seconds before attaching to pump to make sure all pipeline debris is clear. Use an in-line air filter. A 5µ (micron) air filter is recommended.

 **NOTE:** When installing two-piece PTFE diaphragms, it is important to tighten outer pistons simultaneously (turning in opposite directions) to ensure tight fit. (See torque specifications in Section 7.)

 **NOTE:** Before starting disassembly, mark a line from each liquid chamber to its corresponding air chamber. This line will assist in proper alignment during reassembly.

 **CAUTION:** Pro-Flo® SHIFT pumps are available with a single-point-exhaust option. Do not use standard pumps in submersible applications.

 **CAUTION:** Tighten all hardware prior to installation.

Section 2

WILDEN PUMP DESIGNATION SYSTEM

**PS2 SANIFLO™
HYGIENIC SERIES**

**25 mm (1") Pump
Maximum Flow Rate:
121 lpm (32 gpm)**

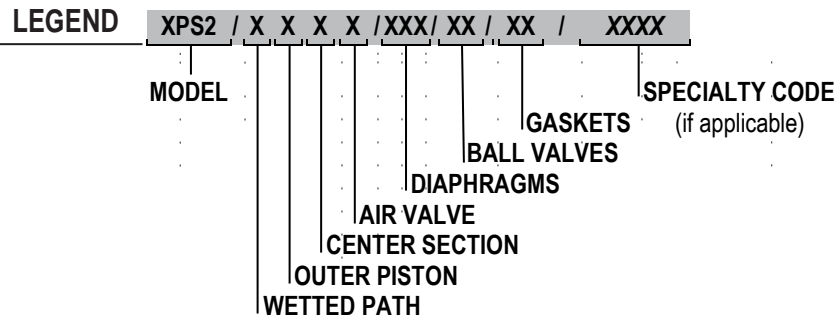

MATERIAL CODES

MODEL
PS2 = 25 mm (1")
XPS2 = 25 mm (1") ATE

WETTED PATH
S = STAINLESS STEEL

OUTER PISTON
S = STAINLESS STEEL
Z = NO PISTON

CENTER SECTION
NN = NICKEL-PLATED ALUMINUM

AIR VALVE
N = NICKEL-PLATED ALUMINUM

DIAPHRAGMS
FBS = SANITARY BUNA^{1,4} (Two Yellow Dots)
FES = SANITARY EPDM^{1,4} (Two Blue Dots)
FSL = FULL-STROKE SANITARY SANIFLEX™ IPD^{1,3,4} [Hytrel® (Cream)]
FSS = SANIFLEX™¹
FWL = FULL-STROKE SANITARY WILFLEX™, IPD^{1,3} [Santoprene® (Two Black Dots)]
FWS = FULL-STROKE SANITARY WIL-FLEX™¹ [Santoprene® (Two Black Dots)]
LEL = PTFE-EPDM BACKED LAMINATE IPD^{1,2,3,4}
TEU = PTFE w/EPDM BACKUP^{1,2,4}
TSU = PTFE w/SANIFLEX™ BACKUP^{1,2,4}
TSS = FULL-STROKE PTFE W/SANIFLEX™ BACK-UP^{1,2,4}
TWS = FULL-STROKE PTFE W/WIL-FLEX™ BACK-UP^{1,2}

BALL VALVES
FB = SANITARY BUNA^{1,3,4} (Red Dot)
FE = SANITARY EPDM^{1,3,4} (Green Dot)
FS = SANIFLEX™^{1,3,4}
TF = PTFE^{1,2,3,4}

GASKETS
FB = SANITARY BUNA-N^{1,3,4} (Red Dot)
FE = SANITARY EPDM^{1,3,4} (Green Dot)
FV = SANITARY FKM^{1,3,4} (One White/One Yellow Dot)
TF = PTFE^{1,2,3,4}

NOTES:
¹ Meets Requirements of FDA CFR21.177
² Meets Requirements of USP Class VI
³ Required for 3-A Certification
⁴ Meets Requirements of 1935/2004/EC

SPECIALTY CODES

0770	Saniflo HS	0770E	Saniflo HS (1935/2004/EC)
0771	Saniflo HS, w/Swivel Stand	0771E	Saniflo HS, w/Swivel Stand (1935/2004/EC)
0772	Saniflo HS, Wil-Gard 110V	0772E	Saniflo HS, Wil-Gard 110V (1935/2004/EC)
0773	Saniflo HS, Wil-Gard 220V	0773E	Saniflo HS, Wil-Gard 220V (1935/2004/EC)
0774	Saniflo HS, Wil-Gard 110V w/Swivel Stand (Required for 3-A cert.)	0774E	Saniflo HS, Wil-Gard 110V w/Swivel Stand, Required for 3-A cert. (1935/2004/EC)
0775	Saniflo HS, Wil-Gard 220V w/Swivel Stand (Required for 3-A cert.)	0775E	Saniflo HS, Wil-Gard 220V w/Swivel Stand, Required for 3-A cert. (1935/2004/EC)
0778	Saniflo HS DIN Connection	0778E	Saniflo HS, DIN Connection (1935/2004/EC)
0779	Saniflo HS, w/Swivel Stand DIN Connection	0779E	Saniflo HS, w/Swivel Stand DIN Connection (1935/2004/EC)
0780	Saniflo HS, Wil-Gard 110V DIN Connection	0780E	Saniflo HS, Wil-Gard 110V DIN Connection (1935/2004/EC)
0781	Saniflo HS, Wil-Gard 220V DIN Connection	0781E	Saniflo HS, Wil-Gard 220V DIN Connection (1935/2004/EC)
0782	Saniflo HS, Wil-Gard 110V w/Swivel Stand DIN Connection	0782E	Saniflo HS, Wil-Gard 110V w/Swivel Stand DIN Connection (1935/2004/EC)
0783	Saniflo HS, Wil-Gard 220V w/Swivel Stand DIN Connection	0783E	Saniflo HS, Wil-Gard 220V w/Swivel Stand DIN Connection (1935/2004/EC)
0784	Saniflo HS SMS Connection	0784E	Saniflo HS, SMS Connection (1935/2004/EC)
0785	Saniflo HS, w/Swivel Stand SMS Connection	0785E	Saniflo HS, w/Swivel Stand SMS Connection (1935/2004/EC)
0786	Saniflo HS, Wil-Gard 110V SMS Connection	0786E	Saniflo HS, Wil-Gard 110V SMS Connection (1935/2004/EC)
0787	Saniflo HS, Wil-Gard 220V SMS Connection	0787E	Saniflo HS, Wil-Gard 220V SMS Connection (1935/2004/EC)
0788	Saniflo HS, Wil-Gard 110V w/Swivel Stand SMS Connection	0788E	Saniflo HS, Wil-Gard 110V w/Swivel Stand SMS Connection (1935/2004/EC)
0789	Saniflo HS, Wil-Gard 220V w/Swivel Stand SMS Connection	0789E	Saniflo HS, Wil-Gard 220V w/Swivel Stand SMS Connection (1935/2004/EC)

NOTE: Most Elastomeric materials use colored dots for identification.
NOTE: Not all models are available with all material options.

Hytrel® is a registered trademark of DuPont Dow Elastomers.
Santoprene® is a registered trademark of Monsanto Company, licensed to Advanced Elastomer Systems, L.P.

Section 3

HOW IT WORKS — PUMP

The Wilden diaphragm pump is an air-operated, positive displacement, self-priming pump. These drawings show flow pattern through the pump upon its initial stroke. It is assumed the pump has no fluid in it prior to its initial stroke.

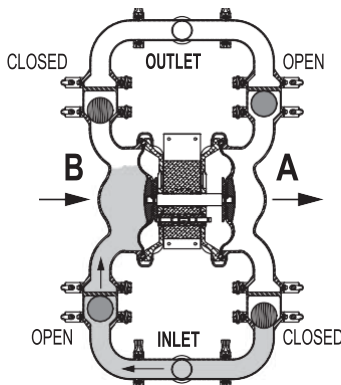

FIGURE 1 The air valve directs pressurized air to the back side of diaphragm A. The compressed air is applied directly to the liquid column separated by elastomeric diaphragms. The diaphragm acts as a separation membrane between the compressed air and liquid; a balanced load removes mechanical stress from the diaphragm. The compressed air moves the diaphragm away from the center of the pump. The opposite diaphragm is pulled in by the shaft connected to the pressurized diaphragm. Diaphragm B is on its suction stroke; air behind the diaphragm has been forced out to atmosphere through the exhaust port of the pump. The movement of diaphragm B toward the center of the pump creates a vacuum within chamber B. Atmospheric pressure forces fluid into the inlet manifold forcing the inlet valve ball off its seat. Liquid is free to move past the inlet valve ball and fill the liquid chamber (see shaded area).

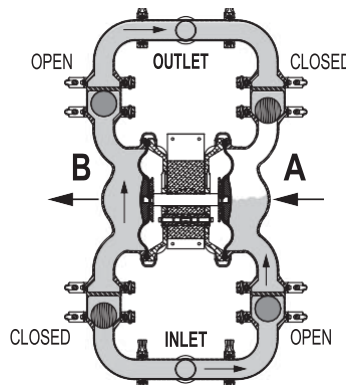

FIGURE 2 When the pressurized diaphragm, diaphragm A, reaches the limit of its discharge stroke, the air valve redirects pressurized air to the back side of diaphragm B. The pressurized air forces diaphragm B away from the center while pulling diaphragm A to the center. Diaphragm B is now on its discharge stroke. Diaphragm B forces the inlet valve ball onto its seat due to the hydraulic forces developed in the liquid chamber and manifold of the pump. These same hydraulic forces lift the discharge valve ball off its seat, while the opposite discharge valve ball is forced onto its seat, forcing fluid to flow through the pump discharge. The movement of diaphragm A toward the center of the pump creates a vacuum within liquid chamber A. Atmospheric pressure forces fluid into the inlet manifold of the pump. The inlet valve ball is forced off its seat allowing the fluid being pumped to fill the liquid chamber.

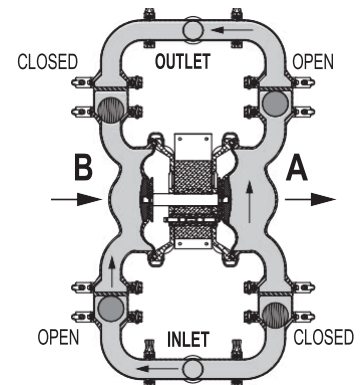
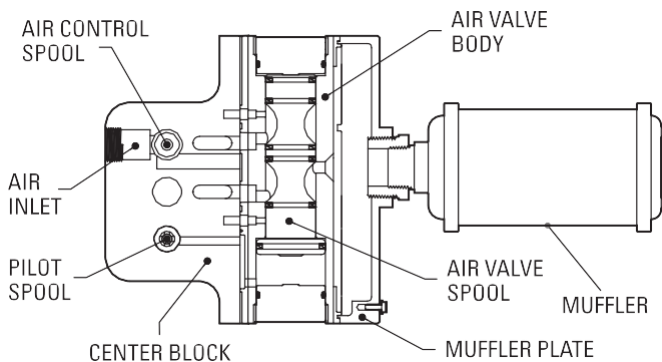

FIGURE 3 At completion of the stroke, the air valve again redirects air to the back side of diaphragm A, which starts diaphragm B on its exhaust stroke. As the pump reaches its original starting point, each diaphragm has gone through one exhaust and one discharge stroke. This constitutes one complete pumping cycle. The pump may take several cycles to completely prime depending on the conditions of the application.

HOW IT WORKS — AIR DISTRIBUTION SYSTEM



The heart of the patented Pro-Flo® SHIFT Air Distribution System (ADS) is the air valve assembly. The air valve design incorporates an unbalanced spool with the small end of the spool being pressurized continuously while the large end of the spool is alternately pressurized, then exhausted to move the spool. The air valve spool directs pressurized air to one chamber while exhausting the other. The air forces the main shaft/diaphragm assembly to move to one side – discharging liquid on that side and pulling liquid in on the other side. When the shaft reaches the end of the stroke, the inner piston actuates the pilot spool, which controls the air to the large end of the air valve spool. The repositioning of the air valve spool routes the air to the other air chamber.

Section 4

DIMENSIONAL DRAWING

PS2 Saniflo™ HS, Swivel

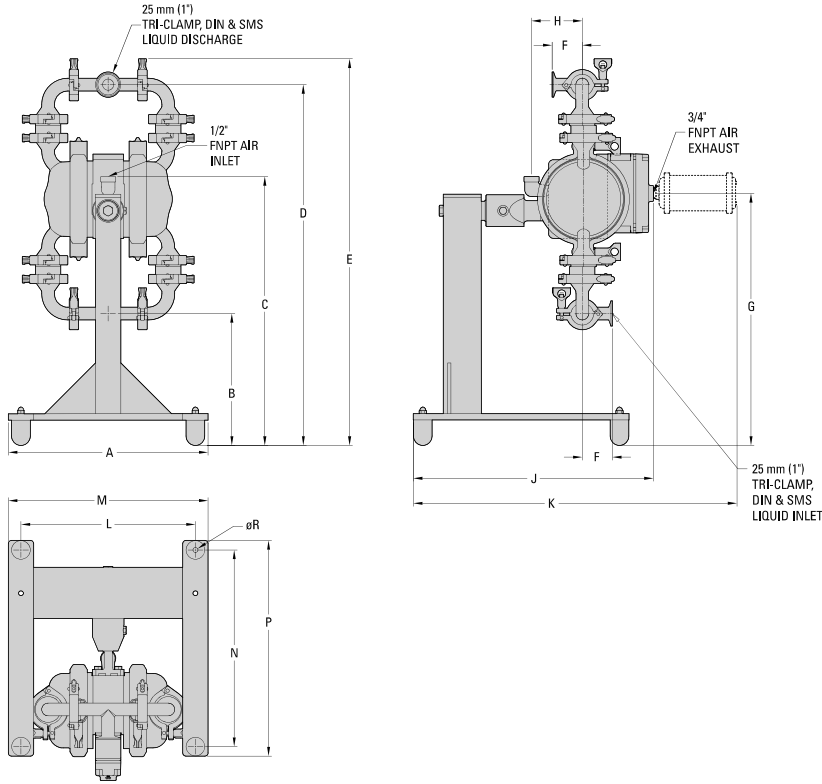

DIMENSIONS

ITEM	METRIC (mm)	STANDARD (inch)
A	401	15.8
B	264	10.4
C	538	21.2
D	721	28.4
E	775	30.5
F	61	2.4
G	505	19.9
H	104	4.1
J	480	18.9
K	648	25.5
L	351	13.8
M	401	15.8
N	394	15.5
P	432	17.0
R	ø10	ø.4

LW0436, Rev. A

PS2 Saniflo™ HS, Vertically- Mounted, Fixed

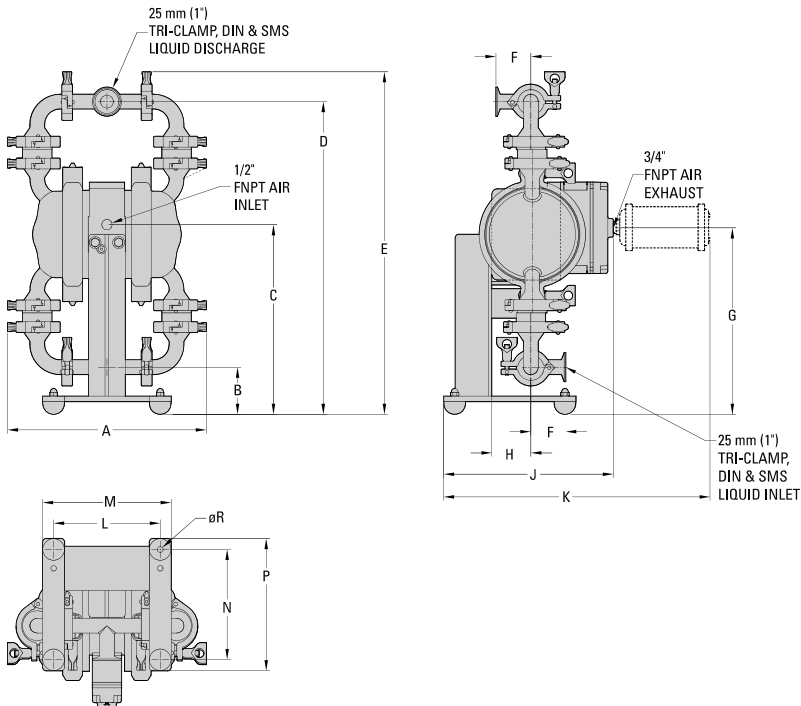

DIMENSIONS

ITEM	METRIC (mm)	STANDARD (inch)
A	343	13.5
B	81	3.2
C	327	12.9
D	540	21.3
E	591	23.3
F	61	2.4
G	322	12.7
H	69	2.7
J	292	11.5
K	460	18.1
L	185	7.3
M	224	8.8
N	191	7.5
P	229	9.0
R	ø10	ø0.4

LW0435, Rev. A

Section 5

PERFORMANCE

**PS2 SANIFLO™ HS
RUBBER-FITTED**

Ship Weight..... 40 kg (80 lb.)
 Air Inlet..... 1/2"
 Inlet..... 25 mm (1")
 Outlet..... 25 mm (1")
 Suction Lift..... 3.9 m Dry (13')
 7.6 m Wet (25')
 Disp. Per Stroke¹..... 0.2 L (0.07 gal.)
 Max. Flow Rate..... 121 lpm (32 gpm)
 Max. Size Solids..... 6.4 mm (1/4")

¹Displacement per stroke was calculated at 4.8 bar (70 psig) air inlet pressure against a 2.1 bar (30 psig) head pressure.

Example: To pump 87 lpm (23 gpm) against a discharge head of 2.8 bar (40 psig) requires 6.9 bar (100 psig) and 68 Nm³/h (40 scfm) air consumption.

Caution: Do not exceed 8.6 bar (125 psig) air supply pressure.

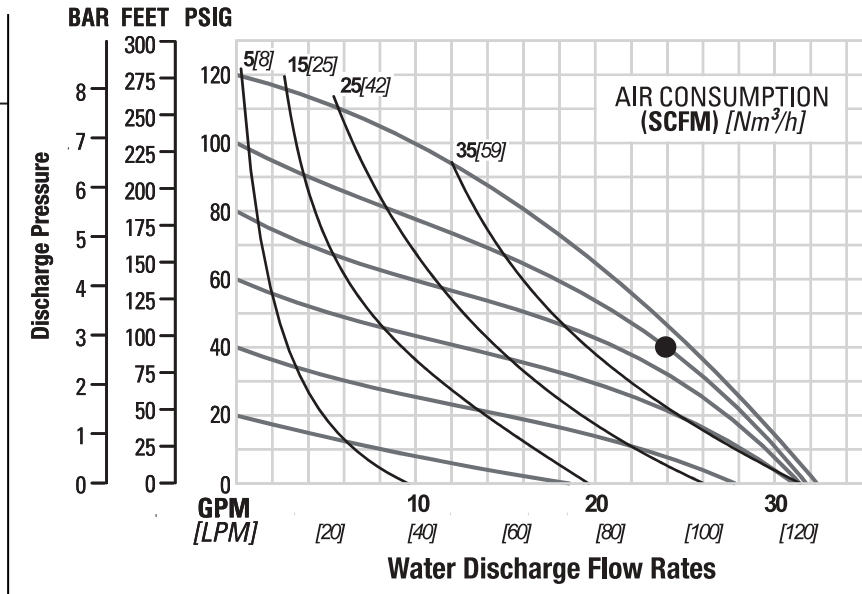

Flow rates indicated on chart were determined by pumping water.

For optimum life and performance, pumps should be specified so that daily operation parameters will fall in the center of the pump's performance curve.

**PS2 SANIFLO™ HS
FULL-STROKE TPE
INTEGRAL PISTON
DIAPHRAGM-FITTED**

Ship Weight..... 40 kg (80 lb.)
 Air Inlet..... 1/2"
 Inlet..... 25 mm (1")
 Outlet..... 25 mm (1")
 Suction Lift..... 2.4 m Dry (8')
 7.9 m Wet (26')
 Disp. Per Stroke¹..... 0.2 L (0.07 gal.)
 Max. Flow Rate..... 117 lpm (31 gpm)
 Max. Size Solids..... 6.4 mm (1/4")

¹Displacement per stroke was calculated at 4.8 bar (70 psig) air inlet pressure against a 2.1 bar (30 psig) head pressure.

Example: To pump 41 lpm (11 gpm) against a discharge head of 2.8 bar (40 psig) requires 4.1 bar (60 psig) and 35 Nm³/h (21 scfm) air consumption.

Caution: Do not exceed 8.6 bar (125 psig) air supply pressure.

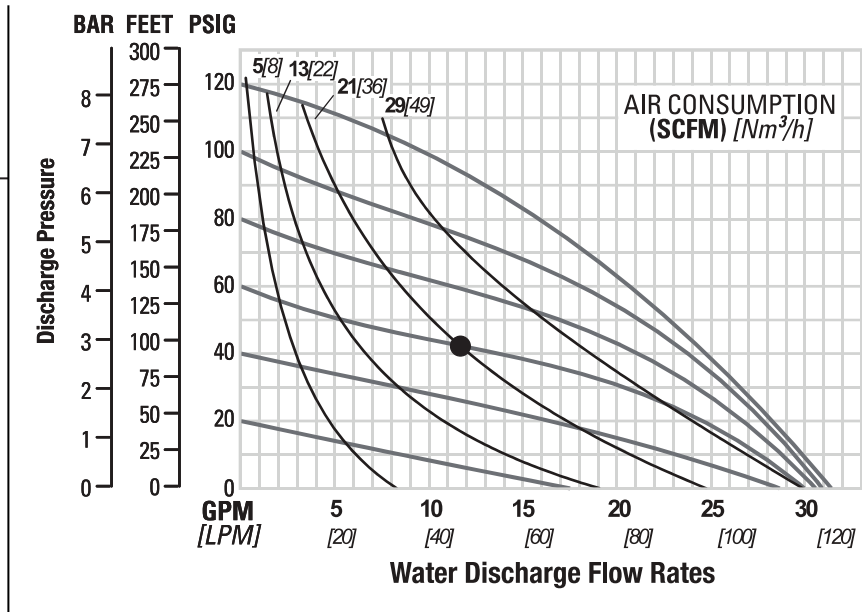

Flow rates indicated on chart were determined by pumping water.

For optimum life and performance, pumps should be specified so that daily operation parameters will fall in the center of the pump's performance curve.

PERFORMANCE

PS2 SANIFLO™ HS FULL-STROKE TPE-FITTED

Ship Weight 40 kg (80 lb.)
Air Inlet 1/2"
Inlet 25 mm (1")
Outlet 25 mm (1")
Suction Lift 1.2 m Dry (4')
7.9 m Wet (26')

Disp. Per Stroke¹ 0.2 L (0.07 gal.)
Max. Flow Rate 109 lpm (29 gpm)
Max. Size Solids 6.4 mm (1/4")

¹Displacement per stroke was calculated at 4.8 bar (70 psig) air inlet pressure against a 2.1 bar (30 psig) head pressure.

Example: To pump 22 lpm (6 gpm) against a discharge head of 6.2 bar (90 psig) requires 6.9 bar (100 psig) and 35 Nm³/h (21 scfm) air consumption.

Caution: Do not exceed 8.6 bar (125 psig) air supply pressure.

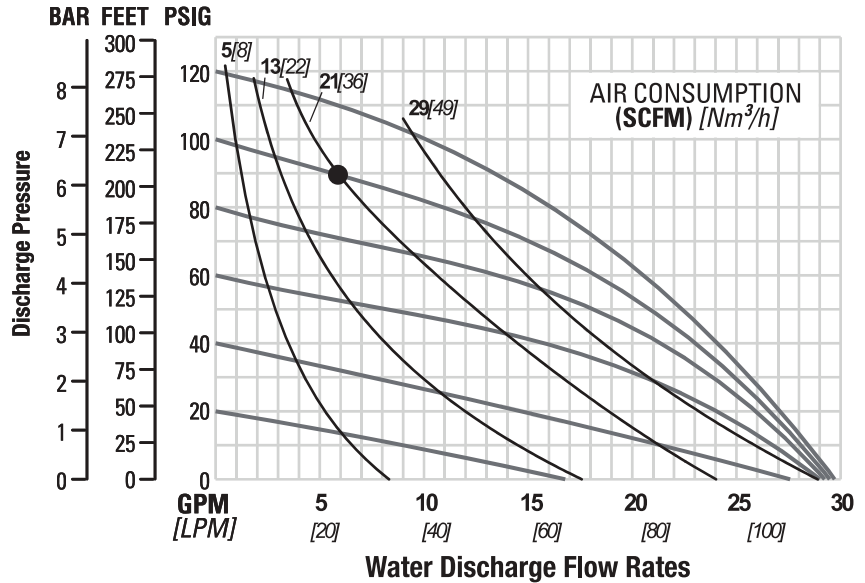

Flow rates indicated on chart were determined by pumping water.

For optimum life and performance, pumps should be specified so that daily operation parameters will fall in the center of the pump's performance curve.

PS2 SANIFLO™ HS FULL-STROKE PTFE-FITTED

Ship Weight 40 kg (80 lb.)
Air Inlet 1/2"
Inlet 25 mm (1")
Outlet 25 mm (1")
Suction Lift 1.5 m Dry (10')
7.6 m Wet (25')

Disp. Per Stroke¹ 0.22 L (0.06 gal.)
Max. Flow Rate 117 lpm (31 gpm)
Max. Size Solids 6.4 mm (1/4")

¹Displacement per stroke was calculated at 4.8 bar (70 psig) air inlet pressure against a 2.1 bar (30 psig) head pressure.

Example: To pump 18 lpm (5 gpm) against a discharge head of 5.5 bar (80 psig) requires 6.9 bar (100 psig) and 36 Nm³/h (21 scfm) air consumption.

Caution: Do not exceed 8.6 bar (125 psig) air supply pressure.

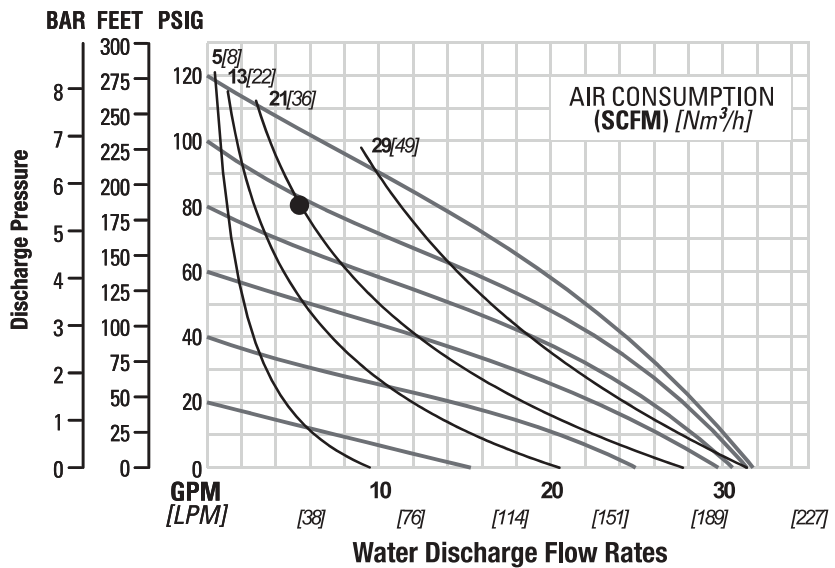

Flow rates indicated on chart were determined by pumping water.

For optimum life and performance, pumps should be specified so that daily operation parameters will fall in the center of the pump's performance curve.

SUCTION LIFT CURVES

PS2 SANIFLO™ HS FULL-STROKE SUCTION – LIFT CAPABILITY

Suction lift curves are created using pumps operating at 305m (1000') above sea level. This chart is meant to be a guide only. There are many variables which can affect the pump's operating characteristics. Suction lift can be affected by the number of intake/discharge elbow, viscosity of pumping fluid, elevation (atmospheric pressure), pipe friction losses and other factors.

Caution: Do not exceed 8.6 bar (125 psig) air supply pressure.

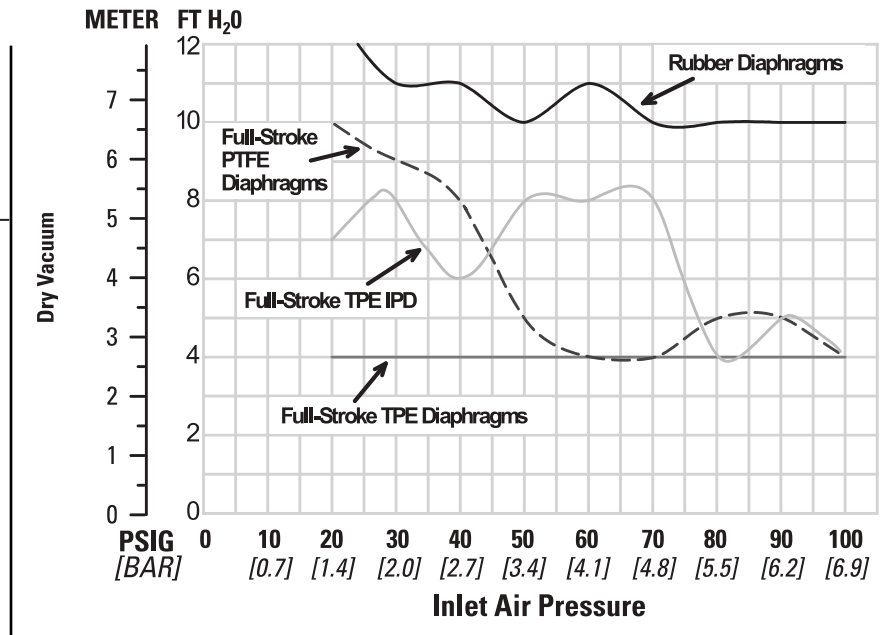

Section 6

Suggested Installation, Operation, Maintenance and Troubleshooting

Wilden pumps are designed to meet the performance requirements of even the most demanding pumping applications. They have been designed and manufactured to the highest standards and are available in a variety of liquid path materials to meet your chemical resistance needs. Refer to the performance section of this manual for an in-depth analysis of the performance characteristics of your pump. Wilden offers the widest variety of elastomer options in the industry to satisfy temperature, chemical compatibility, abrasion resistance and flex concerns.

The suction pipe size should be equivalent or larger than the diameter of the suction inlet on your Wilden pump. The suction hose must be non-collapsible, reinforced type as these pumps are capable of pulling a high vacuum. Discharge piping should also be equivalent or larger than the diameter of the pump discharge to minimize friction losses. It is critical that all fittings and connections are airtight or a reduction or loss of pump suction capability will result.



CAUTION: All fittings and connections must be airtight. Otherwise, pump suction capability will be reduced or lost.

Months of careful planning, study and selection efforts can result in unsatisfactory pump performance if installation details are left to chance. Premature failure and long-term dissatisfaction can be avoided if reasonable care is exercised throughout the installation process.

Location

Noise, safety and other logistical factors usually dictate where equipment will be situated on the production floor. Multiple installations with conflicting requirements can result in congestion of utility areas, leaving few choices for additional pumps.

Within the framework of these and other existing conditions, every pump should be located in such a way that the following key factors are balanced against each other to maximum advantage:

- **Access:** First of all, the location should be accessible. If it's easy to reach the pump, maintenance personnel will have an easier time carrying out routine inspections and adjustments. Should major repairs become necessary, ease of access can play a key role in speeding the repair process and reducing total downtime.
- **Air Supply:** Every pump location should have an air line large enough to supply the volume of air necessary to achieve the desired pumping rate. Do not exceed the maximum rated air pressure.

For best results, the pumps should use a 5µ (micron) air filter, needle valve and regulator. The use of an air filter before the pump will ensure that the majority of any pipeline contaminants will be eliminated.

- **Solenoid Operation:** When operation is controlled by a solenoid valve in the air line, three-way valves should be used. This valve allows trapped air between the valve and the pump to bleed off, which improves pump performance. You can estimate pumping volume by counting the number of strokes per minute, and then multiplying that figure by the displacement per stroke.
- **Muffler:** Sound levels are reduced below OSHA specifications using the standard Wilden muffler. Other mufflers can be used to further reduce sound levels, but they usually reduce pump performance.

- **Elevation:** Selecting a site that is well within the pump's dynamic lift capability will assure that loss-of-prime issues will be eliminated. In addition, pump efficiency can be adversely affected if proper attention is not given to site location.

- **Piping:** Final determination of the pump site should not be made until the piping challenges of each possible location have been evaluated. The impact of current and future installations should be considered ahead of time to make sure that inadvertent restrictions are not created for any remaining sites.

The best choice possible will be a site involving the shortest and straightest hook-up of suction and discharge piping. Unnecessary elbows, bends and fittings should be avoided. Pipe sizes should be selected to keep friction losses within practical limits. All piping should be supported independently of the pump. In addition, the piping should be aligned to avoid placing stress on the pump fittings.

Flexible hose can be installed to aid in absorbing the forces created by the natural reciprocating action of the pump. If the pump is to be bolted down to a solid location, a mounting pad placed between the pump and the foundation will assist in minimizing pump vibration. Flexible connections between the pump and rigid piping will also assist in minimizing pump vibration. If quick-closing valves are installed at any point in the discharge system, or if pulsation within a system becomes a problem, a surge suppressor (SD Equalizer®) should be installed to protect the pump, piping and gauges from surges and water hammer.

If the pump is to be used in a self-priming application, make sure that all connections are airtight and that the suction lift is within the model's ability.



NOTE: Materials of construction and elastomer material have an effect on suction-lift parameters. Please refer to the performance section for specifics.

When pumps are installed in applications involving flooded suction or suction head pressures, a gate valve should be installed in the suction line to permit closing of the line for pump service.

Pumps in service with a positive suction head are most efficient when inlet pressure is limited to 0.5–0.7 bar (7–10 psig). Premature diaphragm failure may occur if positive suction is 0.7 bar (10 psig) and higher.

Single-Point Exhaust

Pro-Flo SHIFT pumps can be used for submersible applications, when using the Pro-Flo SHIFT single-point exhaust option.



CAUTION: All Wilden pumps are capable of passing solids. A strainer should be used on the pump intake to ensure that the pump's rated solids capacity is not exceeded.

Suggested Installation, Operation, Maintenance and Troubleshooting

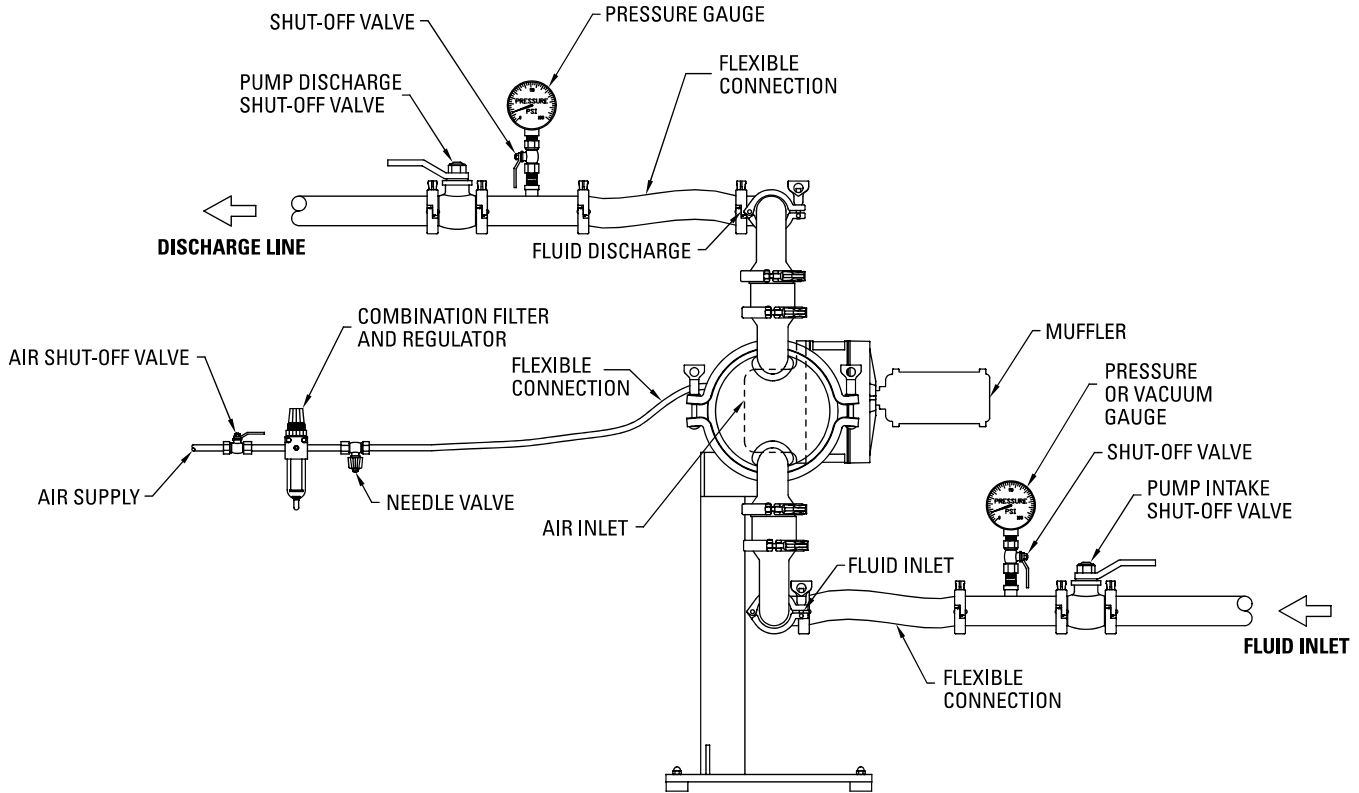

NOTE: In the event of a power failure, the air shut-off valve should be closed, if restarting of the pump is not desirable once power is regained.

Air-Operated Pumps: To stop the pump from operating in an emergency situation, simply close the air shut-off valve (user-supplied) installed in the air supply line. A properly functioning valve will stop the air supply to the pump, therefore stopping output. This air shut-off valve should be located far enough away from the pumping equipment such that it can be reached safely in an emergency situation.

Operation

The Pro-Flo SHIFT pumps are pre-lubricated and do not require in-line lubrication. Additional lubrication will not damage the pump. However, if the pump is heavily lubricated by an external source, the pump's internal lubrication may be washed away. If the pump is then moved to a nonlubricated location, it may need to be disassembled and re-lubricated as described in "Disassembly/Reassembly" on page 14.

Pump discharge rate can be controlled by limiting the volume and/or pressure of the air supply to the pump. An air regulator is used to

regulate air pressure. A needle valve is used to regulate volume. Pump discharge rate also can be controlled by throttling the pump discharge by partially closing a valve in the discharge line of the pump. This action increases friction loss, which reduces flow rate. (See "Performance" on page 8.) This is useful when the need exists to control the pump from a remote location. When the pump discharge pressure equals or exceeds the air supply pressure, the pump will stop. No bypass or pressure relief valve is needed, and pump damage will not occur. The pump has reached a "deadhead" situation and can be restarted by reducing the fluid discharge pressure or increasing the air inlet pressure. Wilden Pro-Flo SHIFT pumps run solely on compressed air and do not generate heat.

Therefore, your process fluid temperature will not be affected.

Maintenance and Inspections

Because each application is unique, maintenance schedules may be different for every pump. Frequency of use, line pressure, viscosity and abrasiveness of process fluid all affect the parts life of a Wilden pump. Periodic inspections have been found to offer the best means for preventing unscheduled pump downtime. Personnel familiar with the pump's construction and service should be informed of any abnormalities that are detected during operation.

Suggested Installation, Operation, Maintenance and Troubleshooting

Troubleshooting

Pump will not run or runs slowly.

1. Remove plug from pilot spool exhaust.
2. Ensure that the air inlet pressure is at least 0.4 bar (5 psig) above startup pressure and that the differential pressure (the difference between air inlet and liquid discharge pressures) is not less than 0.7 bar (10 psig).
3. Check air inlet filter for debris (see "Suggested Installation, Operation, Maintenance and Troubleshooting" on page 11).
4. Check for extreme air leakage (blow by) that would indicate worn seals/bores in the air valve, pilot spool and main shaft.
5. Disassemble the pump and check for obstructions in the air passageways or objects that would obstruct the movement of internal parts.
6. Check for sticking ball check valves.
 - a. If material being pumped is not compatible with pump elastomers, swelling may occur. Replace ball check valves and seals with proper elastomers.
 - b. Also, as the check valve balls wear out, they become smaller and can become stuck in the seats. In this case, replace balls and seats.
7. Check for any broken inner piston that would cause the air valve spool to be unable to shift.

3. Check for sticking ball check valves.
 - a. If material being pumped is not compatible with pump elastomers, swelling may occur. Replace ball check valves and seals with proper elastomers.
 - b. Also, as the check valve balls wear out, they become smaller and can become stuck in the seats. In this case, replace balls and seats.

Pump air valve freezes.

1. Check for excessive moisture in the compressed air.
 - a. Either install a dryer or a hot air generator for compressed air.
 - b. Alternatively, you may use coalescing filter to remove the water from the compressed air in some applications.

Air bubbles in pump discharge.

1. Check for a ruptured diaphragm.
2. Check tightness of outer pistons (see Disassembly/Reassembly on page 14).
3. Check tightness of fasteners and integrity of O-rings and seals, especially at intake manifold.
4. Ensure pipe connections are airtight.

Product comes out air exhaust.

1. Check for a diaphragm rupture.
2. Check the tightness of the outer pistons to the shaft.

Pump runs, but little or no product flows.

1. Check for pump cavitation. Slow pump speed down to allow thick material to flow into liquid chambers.
2. Verify that vacuum required to lift liquid is not greater than the vapor pressure of the material being pumped (cavitation).

Section 7

Disassembly / Reassembly

Pump Disassembly

Tools Required:

- Adjustable Wrench
- Vise equipped with soft jaws (such as plywood, plastic or other suitable material)



CAUTION: Before any maintenance or repair is attempted, the compressed air line to the pump should be disconnected and all air pressure allowed to bleed from the pump. Disconnect all intake, discharge and air lines. Drain the pump by turning it upside down and allowing any fluid to flow into a suitable container. Be aware of any hazardous effects of contact with your process fluid.



NOTE: The model photographed for these instructions incorporates PTFE diaphragms.

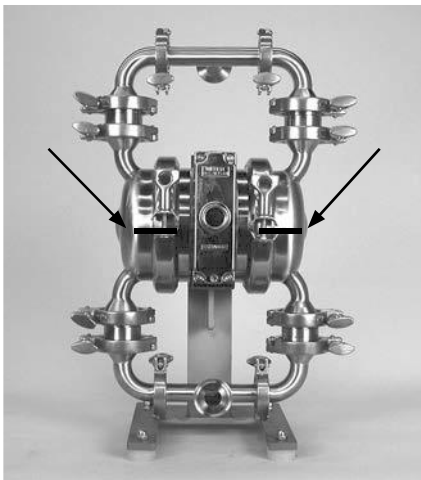

Step 1

Prior to assembly, alignment marks should be placed on the liquid chambers and air chambers to assist with proper alignment during reassembly.



Step 2

Loosen the wing nut and remove both discharge manifold clamp bands.



Step 3

Remove the discharge manifold and manifold gaskets.

Disassembly / Reassembly



Step 4

Next, remove the clamp bands that secure the ball valve housing to the liquid chamber.



Step 5

Next, remove the ball valve housing, valve ball and gasket.



Step 6

Loosen the wing nut and remove the inlet manifold clamp bands.



Step 7

Next, remove the clamp bands that secure the ball valve housing to the liquid chamber.



Step 8

Next, remove the ball valve housing, valve ball and gasket from liquid chamber. To ensure proper alignment during reassembly of manifold/liquid chamber interface, turn off-set portion of valve housing to the left or to the right. This procedure works for the inlet manifold and discharge manifold connections.



Step 9

Now the large clamp bands can be removed.



NOTE: Prior to assembly, alignment marks should be placed on the liquid chambers and air chambers to assist with proper alignment during reassembly.

Disassembly / Reassembly



Step 10A

Next, remove the liquid chamber from the center section assembly.



Step 10B

If your pump is fitted with an integral piston diaphragm (IPD), when you remove the liquid chamber you will notice that there is no outer piston.



Step 11A

Using two (2) adjustable wrenches, turning in the opposite direction, loosen and remove one of the two outer pistons.



Step 11B

If your pump is fitted with an IPD, the procedure for removing the diaphragm is slightly different. In this case, simply grasp the diaphragm in two locations and turn in a counterclockwise direction.



Step 12A

After loosening and removing the outer piston, the remaining diaphragm assembly and shaft can be removed from the center section assembly..



Step 12B

If your pump is fitted with an IPD, the procedure for removing the diaphragm is the same.

Wil-Gard™ Diaphragm Sensor

Wil-Gard™ Diaphragm Sensor Removal



Step 1

After removing the inlet and discharge manifold assemblies, disconnect the Wil-Gard™ module from the sensor wires.



Step 2

Next, remove the large clamp bands and the liquid chamber on either side of the pump.



Step 3

The Wil-Gard™ sensor cables can be easily removed from the diaphragm assembly by simply pulling them from between the primary

Wil-Gard™ Diaphragm Sensor Installation



Step 1

The Wil-Gard™ sensor wires must be installed between the primary diaphragm and the back-up diaphragm, on both sides of the pump, at the six o'clock position. They should be positioned approximately half the distance to the shaft from the edge of the diaphragm.



Step 2

Prior to installing the liquid chamber, and after positioning the Wil-Gard™ sensor cable between the primary and back-up diaphragms, run the sensor cable along the diaphragm bead but outside the pump. Now install the liquid chamber and large clamp band.



Step 3

When installing the liquid chamber and large clamp band, route the Wil-Gard™ sensor cable to the inside of the large clamp-band fastener. Next, reconnect the Wil-Gard™ module.



NOTE: Use caution to ensure that the sensor wires are not damaged or pinched by the clamp band.

Swivel Pump Stand Option

For ease of maintenance and cleaning, Wilden offers an optional swivel pump stand. The swivel pump stand allows the pump to be drained by rotating the pump so that the fluid can flow out of the discharge and into a suitable container

Draining Pump Contents

To drain the pump of its contents, first disconnect the inlet and discharge connections. Next loosen the anti-rotation bolt (item #1) by turning counter-clockwise. Do not remove the bolt; only loosen the bolt two turns. After loosening the anti-rotation bolt, rotate pump 180°. This will allow the contents within the pump to flow out of the discharge and into a suitable container. After draining the pump, rotate the pump back to the upright position and tighten the anti-rotation bolt.

Removing Pump From Swivel Pump Stand

Saniflo™ HS pumps are very heavy. It is recommended that the pump be disassembled while attached to the stand. If it is necessary to remove the pump from the stand while fully assembled, use a hoist or mechanical means to support the pump as it is removed from the stand.

To remove your Saniflo™ HS pump from the swivel pump stand, first loosen the anti-rotation bolt (item #1) by turning counter-clockwise. Next, ensure the entire pump weight is supported by hoist and loosen the locking pin (item #2) by turning counter-clockwise. This will allow the pump to be removed from the stand.



CAUTION: Removal of the locking pin (item #2) will allow the pump to fall from the stand, potentially causing injury to the operator or personnel in the immediate area. Never operate or store the pump without the locking pin (item #2) in place and properly torqued.



NOTE: The center block-to-bushing bolts (item #4) attach the center block mounting bushing (item #3) to the center block (not shown). These bolts do not need to be removed to remove the pump from the stand.



NOTE: Torque values are located in Section 7 of this manual.

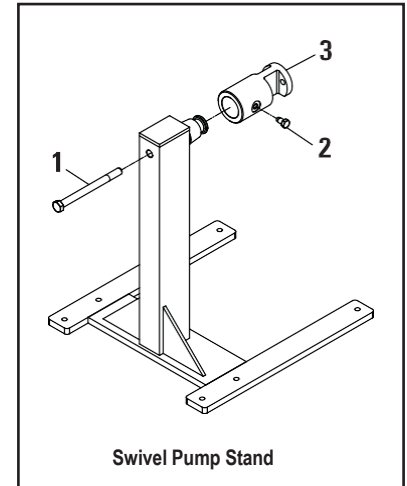

Disassembly / Reassembly

Air Valve / Center Section Disassembly

Tools Required:

- 3/16" Hex-Head Wrench
- Snap-Ring Pliers
- O-Ring Pick
- 9/16" Wrench



CAUTION: Before any maintenance or repair is attempted, the compressed air line to the pump should be disconnected and all air pressure allowed to bleed from the pump. Disconnect all intake, discharge and air lines. Drain the pump by turning it upside down and allowing any fluid to flow into a suitable container. Be aware of hazardous effects of contact with your process fluid.



NOTE: Replace worn parts with genuine Wilden parts for reliable performance.

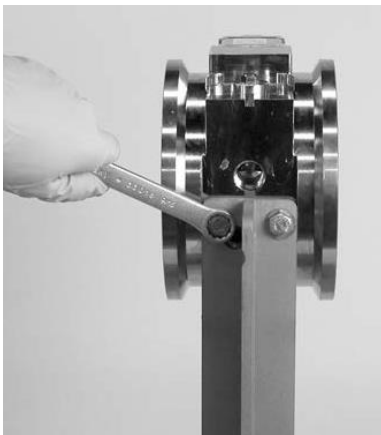

Step 1

Using a 9/16" wrench, loosen the bolts that connect the center section to the stand.



Step 2

Remove the center section from the stand.



Step 3

Using a 3/16" hex wrench, loosen air valve bolts.



CAUTION: With bolts removed, the center section is no longer attached to the stand and must be supported so that it does not fall from the stand.

Disassembly / Reassembly



Step 4

Remove muffer plate and air valve bolts from air valve assembly exposing muffer gasket for inspection. Replace, if necessary.



Step 5

Lift away air valve assembly and remove air valve gasket for inspection. Replace, if necessary.



Step 6

Remove air valve end cap to expose air valve spool by simply lifting up on end cap once air valve bolts are removed.



NOTE: Pro-Flo X™ air valve incorporates an end cap at both ends of the air valve.



Step 7

Remove the air valve spool from the air valve body by threading one air valve bolt into the end of the air valve spool and gently sliding the spool out of the air valve body. Inspect seals for signs of wear and replace entire assembly if necessary. Use caution when handling air valve spool to prevent damaging seals.



NOTE: Seals should not be removed from assembly. Seals are not sold separately.



Step 8

Remove pilot sleeve retaining snap ring on both sides of center section with snap-ring pliers.



Step 9

Remove pilot spool sleeve from center section.

Disassembly / Reassembly

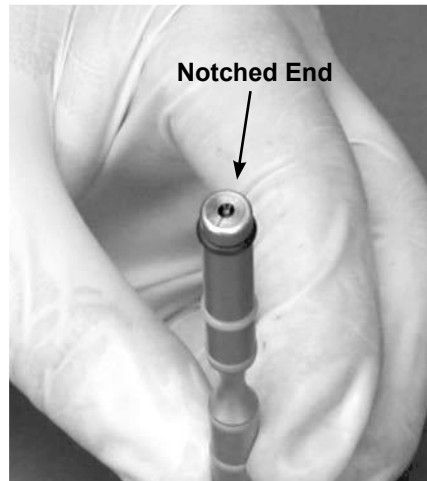

Step 10

Using an O-ring pick, gently remove the O-ring from the opposite side of the notched end on one side of the pilot spool. Gently remove the pilot spool from pilot spool sleeve and inspect for nicks, gouges and wear. Replace pilot sleeve or outer sleeve O-rings if necessary. During reassembly, never insert the pilot spool into the sleeve with the notched end first, this end incorporates the urethane O-ring and will be damaged as it slides over the ports cut in the sleeve.



NOTE: Seals should not be removed from pilot spool.
Seals are not sold separately.

Disassembly / Reassembly

Single-Point Exhaust

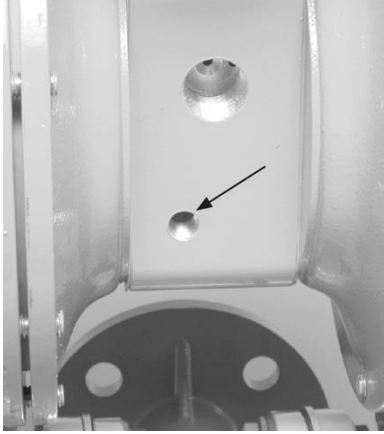

Step 1

Remove the pilot exhaust muffler in the pilot bleed port located at the front of the center block.

Install 1/4" NPT pipe plug (00-7010-08) into the bleed port.

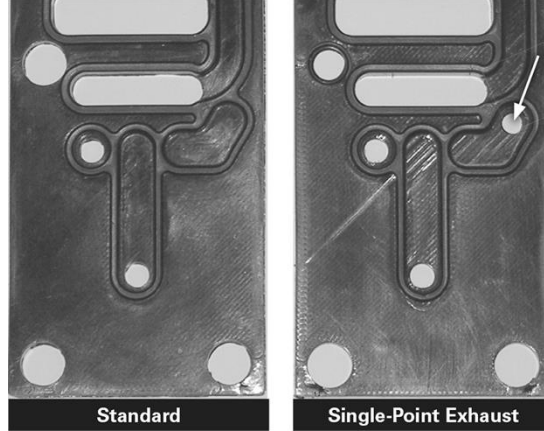

Step 2

Optional: Install a single-point exhaust gasket (04-2639-52). The single-point air valve gasket can be purchased as a spare part or included with the purchase of a new Pro-Flo SHIFT pump.

Reassembly Hints & Tips

Upon performing applicable maintenance to the air distribution system, the pump can now be reassembled. Please refer to the disassembly instructions for photos and parts placement. To reassemble the pump, follow the disassembly instructions in reverse order. The air distribution system needs to be assembled first, then the diaphragms and finally the wetted path.

The following tips will assist in the assembly process:

- Lubricate air valve bore, center section shaft and pilot spool bore with NLGI grade 2 white EP bearing grease or equivalent.
- Clean the inside of the center section shaft bore to ensure no damage is done to new shaft seals.
- A small amount of NLGI grade 2 white EP bearing grease can be applied to the muffler and air valve gaskets to locate gaskets during assembly.
- Make sure that the exhaust port on the muffler plate is centered between the two exhaust ports on the center section.
- Stainless bolts should be lubed to reduce the possibility of seizing during tightening.
- Use a mallet to tap lightly on the large clamp bands to seat the diaphragm before tightening.

PRO-FLO® SHIFT MAXIMUM TORQUE SPECIFICATIONS

Description of Part	Torque
Air Valve	11.3 N.m (100 in-lb)
Dial set screw	11.3 N.m (100 in-lb)
Outer pistons, all diaphragms	47.5 N.m (35 in-lb)
Center block-to-stand bolt	44.7 N.m (33 in-lb)
Center block-to-bushing bolt	44.7 N.m (33 in-lb)
Locking Pin	44.7 N.m (33 in-lb)
Anti-Rotation Bolt	67.8 N.m (50 in-lb)

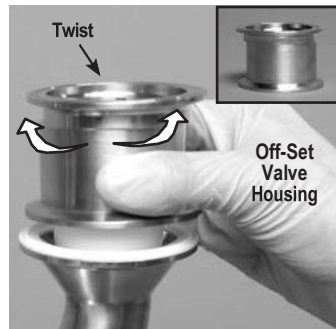

NOTE: To ensure proper alignment during reassembly of manifold/liquid chamber interface, turn off-set portion of valve housing to the left or to the right. This procedure works for the inlet manifold and discharge manifold connections

Disassembly / Reassembly

Shaft Seal Installation

Pre-Installation

Once all of the old seals have been removed, the inside of the bushing should be cleaned to ensure no debris is left that may cause premature damage to the new seals.

Installation

1. Wrap electrical tape around each leg of the needle-nose pliers (heat shrink tubing may also be used). This is done to prevent damaging the inside surface of the new seal.
2. With a new seal in hand, place the two legs of the needle-nose pliers inside the seal ring. (See Figure A.)
3. Open the pliers as wide as the seal diameter will allow, then with two fingers pull down on the top portion of the seal to form a kidney shape. (See Figure B.)
4. Lightly clamp the pliers together to hold the seal into the kidney shape. Be sure to pull the seal into as tight of a kidney shape as possible, this will allow the seal to travel down the bushing bore easier.
5. With the seal clamped in the pliers, insert the seal into the bushing bore and position the bottom of the seal into the correct groove. Once the bottom of the seal is seated in the groove, release the clamp pressure on the pliers. This will allow the seal to partially snap back to its original shape.
6. After the pliers are removed, you will notice a slight bump in the seal shape. Before the seal can be properly resized, the bump in the seal should be removed as much as possible. This can be done with either the Phillips screwdriver or your finger. With either the side of the screwdriver or your finger, apply light pressure to the peak of the bump. This pressure will cause the bump to be almost completely eliminated.
7. Lubricate the edge of the shaft with NLGI grade 2 white EP bearing grease.
8. Slowly insert the center shaft with a rotating motion. This will complete the resizing of the seal.
9. Perform these steps for the remaining seals.

Tools

The following tools can be used to aid in the installation of the new seals:

- Needle-Nose Pliers
- Phillips Screwdriver
- Electrical Tape

Figure A

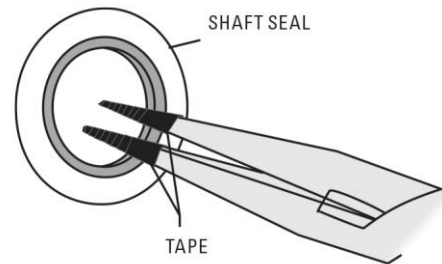
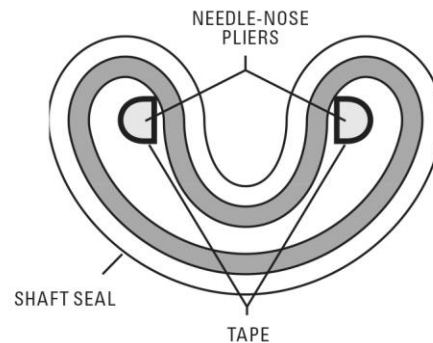

Figure B



Section 8

Clean - In - Place - CIP

The design of the Saniflo HS pump allows for ease of cleaning. The Saniflo HS pump can be cleaned in place without disassembly. Before any cleaning is attempted, ensure that the cleaning fluids are compatible with all wetted components.

For best cleaning results consider the following information prior to cleaning the Saniflo HS pump.

- For best Clean-In-Place (CIP) results, the pump should be configured to either the EHEDG or 3-A configurations.
- Actual CIP effectiveness with pump user's product(s) and processes should be validated on location by the end user's quality assurance personnel to meet internal guidelines. Post cleaning swab test is one method to accomplish this.
- The pump user should establish periodic inspections with full tear down to verify that the CIP processes continue to be effective as first validated.
- Liquid inlet pressure to the pump should not be greater than 0.7 bar (10 psig). Premature diaphragm failure may occur if greater than 0.7 bar (10 psig) is applied. If the pump is to be subjected to greater than
- 0.7 bar (10 psig), an optional diaphragm balancing device is suggested to eliminate the possibility of the diaphragms being forced against the air chamber and subsequently causing premature diaphragm failure.

The following are some details to consider when cleaning the Saniflo HS pump.

- Through the EHEDG certification process, the Saniflo HS pump has been validated to clean equivalent to the inlet tubing of the same diameter. The cleaning chemical supplier should be consulted and advised of this for their chemical solution and application. The same guideline for duration of cleaning cycle and temperature of cleaning fluid apply.

- Suggested flow rate for the PS2 HS pump is 15 gpm minimum/3.4 m³/hr (usually higher is better).
- Typical CIP temperature is 77°C to 82°C (170°F to 180°F).
- Typical chemicals include NaOH (sodium hydroxide) caustic for wash and light acid and sanitizers for rinse.
- Once an initial CIP regimen is established, it may need to be modified to accommodate specific process and product differences or requirements. The most common adjustments include:
 - Changing cleaning time (extended or reduced pre-rinse, wash, rinses)
 - Changing cleaning flow rate
- The cleaning variables are related so that a pump user may be able to reduce the cleaning time by increasing the flow rate or chemical mix.
- Chlorinated sanitizers are known to cause premature failure of stainless steel and should be avoided.

To Clean Pump

- Activate the CIP system while slowly cycling the pump.



NOTE: A typical the CIP temperature limit is 90°C (195°F). If the CIP temperature is greater than 90°C (195°F), damage to the pump may occur.

Section 9

EXPLODED VIEW AND PARTS LISTING

PS2 SANIFLO™ HS

EXPLODED VIEW

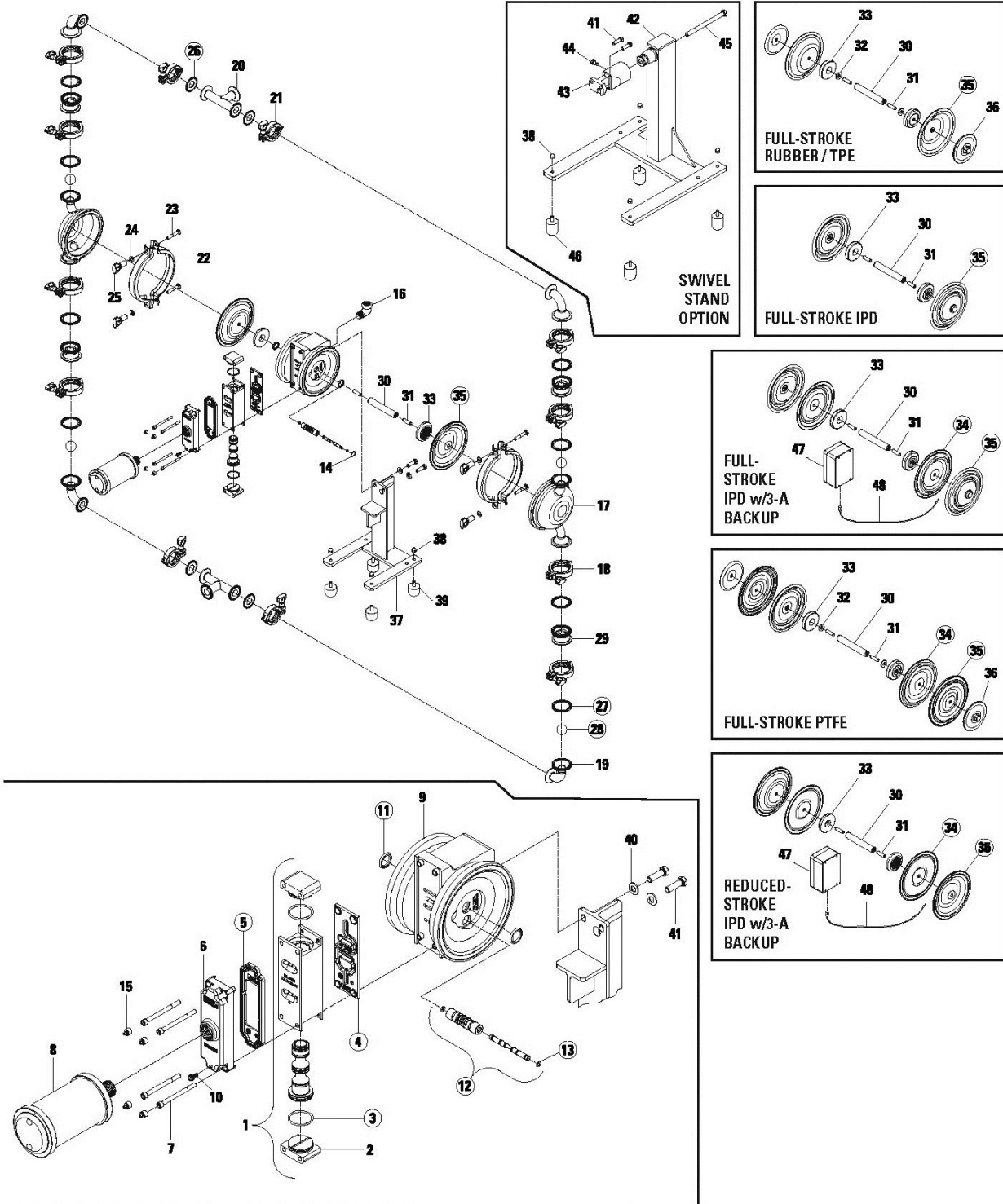

ALL CIRCLED PART IDENTIFIERS ARE INCLUDED IN REPAIR KITS.

LW0437, Rev. B

Exploded View and Parts List

Item	Description	Qty	XPS2 HS	XPS2 HS 3A
Air Distribution Components				
1	Air Valve, Pro-Flo X™ Assembly ¹	1	02-2030-06	
2	End Cap, Pro-Flo X®	2	01-2335-06	
3	O-Ring, End Cap (-126) (Æ1.362 X Æ.103)	2	01-2395-52	
4	Gasket, Air Valve, Pro-Flo X®	1	02-2620-52	
5	Gasket, Muffler Plate, Pro-Flo X®	1	02-3502-52	
6	Muffler Plate, Pro-Flo X®	1	02-3185-06	
7	Screw, SHC, 1/4"-20 X 3"	4	01-6001-03	
8	Muffler	1	08-3510-06R	
9	Center Section Assembly, Pro-Flo SHIFT ²	1	02-3139-06	
10	Screw, 10-32 X .50 Self-Tapping Grounding	1	04-6345-08	
11	Shaft Seal	2	02-3210-55-225	
12	Pilot Sleeve Assembly	1	02-3880-99	
13	Pilot Spool Retaining O-Ring (Æ.208 X Æ.070)	2	04-2650-49-700	
14	Retaining Ring	1	00-2650-03	
15	Plug, 1/4" SHCS (3-A)	4		02-7825-17
16	Elbow, Street, 90° 1/2" NPT ⁶	1	02-7843-03	
Wetted Path Components				
▲ 17	Chamber, Liquid CIP 1" EHEDG	2	02-5002-10-385P	
18	Clamp Band, Assy, Medium	8	02-7200-03-85	
▲ 19	Elbow, 1" EHEDG	4	02-5240-10-385P	
▲ 20	T-Section, 1" EHEDG	2	02-5160-10-385P	
	T-Section, 1" EHEDG DIN	2	02-5160-10-386P	
	T-Section, 1" EHEDG SMS	2	02-5160-10-387P	
21	Clamp Band, Assy, Small	4	02-7100-03-85	
22	Clamp Band Assy, Large ³	2	02-7300-03-385	
23	Bolt, RHSN, 5/16"-18 X 2"	4	08-6050-03-500	
24	Washer, (.344 I.D. X .688 O.D. X .065 THK.)	4	02-6731-03	
25	Wing Nut, Medium Clamp	4	08-6661-10	
Gaskets/Valve Balls				
▲ 26	Gasket, 1"	4		*
▲ 27	Gasket, 2"	8		*
▲ 28	Valve Ball	4		*
Check Valve Components				
▲ 29	Ball Cage, 1" EHEDG	4	02-5350-10-385P	
Full-Stroke Rubber/TPE/PTFE/FSIPD Components				
30	Shaft, P2 Pro-Flo™ (Non-PTFE)	1	02-3810-03	
31	Shaft Stud, 3/8"-16 X 1-1/4"	2	02-6150-03-85	
32	Spring, Disk	2	02-6802-08	
33	Piston, Inner, P2 Pro-Flo™ (Non-PTFE)	2	02-3701-01	
34	Diaphragm, Full Stroke PTFE, Back-Up	2		*
	Diaphragm, Full Stroke IPD, Back-Up (3-A)	2		02-1061-55
▲ 35	Diaphragm, Primary	2		*
	Diaphragm, Full Stroke PTFE, Primary	2	02-1040-55	
	Diaphragm, Full Stroke, IPD, Primary	2		
▲ 36	Piston, Outer, (Non-PTFE)	2	02-4550-10-385P	

LW0438 REV. B

*Refer to Elastomer Chart

▲ Product Contact Components

¹ Air Valve Assembly includes items 2 and 3.

² Center Section Assembly includes items 11.

³ Large Clamp Band Assembly includes items 23, 24 and 25.

⁴ Pump Stand Assembly includes items 38, 39, 40 and 41.

⁵ Swivel Pump Stand Assembly includes items 38, 41, 43, 44, 45 and 46.

⁶ Required for all 1" swivel stand models.

All boldface items are primary wear parts.

Exploded View and Parts List (Cont)

Item	Description	Qty	XPS2 HS	XPS2 HS 3A
Reduced-Stroke SIPD Components				
30	Shaft, Pro-Flo™ (PTFE)	1	02-3840-03	
31	Shaft Stud, 3/8"-16 X 1-1/4"	2	02-6150-03-85	
33	Piston, Inner, P2 Pro-Flo™ (PTFE)	2	02-3751-01	
34	Diaphragm, Back-Up, IPD (3-A)	2		02-1060-55-85
▲ 35	Diaphragm, Integral Piston	2	02-1010-72-85	
Fixed Stand Components				
37	Stand, Pump, Assy. ⁴	1	02-7652-10-385	
38	Nut, Cap, 5/16"-18, Pump Stand	4	08-6600-03-72	
39	Pad, Pump Stand	4	08-7670-20	
40	Washer, (.406 I.D. X .812 O.D. X .065 Thk.)	2	04-6740-03	
41	Screw, HHC, 3/8"-16 X 1-1/4"	2	04-6190-03	
Swivel Stand Components				
42	Pump Stand, Swivel, Assy. ⁵ (3-A)	1	04-7655-03	
43	Bushing, Center Block Mounting	1	15-7665-03	
44	Locking Pin	1	08-7694-03	
45	Screw, HHC, 1/2"-13 X 6"	1	15-6143-03	
41	Screw, HHC, 3/8"-16 X 1-1/4"	2	04-6190-03	
38	Nut, Cap, 5/16"-18, Pump Stand	4	08-6600-03-72	
46	Pad, Pump Stand 2" (3-A)	4	08-7672-20	
Accessory Components				
47	Control Module, Wil-Gard II, 110 (3-A)	1	65-8001-99	
48	Sensor Cables, Wil-Gard II (3-A)	1	65-8020-99	

LW0438 REV. B

*Refer to Elastomer Chart

▲ Product Contact Components

¹ Air Valve Assembly includes items 2 and 3.

² Center Section Assembly includes items 11.

³ Large Clamp Band Assembly includes items 23, 24 and 25.

⁴ Pump Stand Assembly includes items 38, 39, 40 and 41.

⁵ Swivel Pump Stand Assembly includes items 38, 41, 43, 44, 45 and 46.

⁶ Required for all 1" swivel stand models.

All boldface items are primary wear parts.

EXPLODED VIEW AND PARTS LISTING

PS2 SANIFLO™ HS

1935 /2004/EC

EXPLODED VIEW

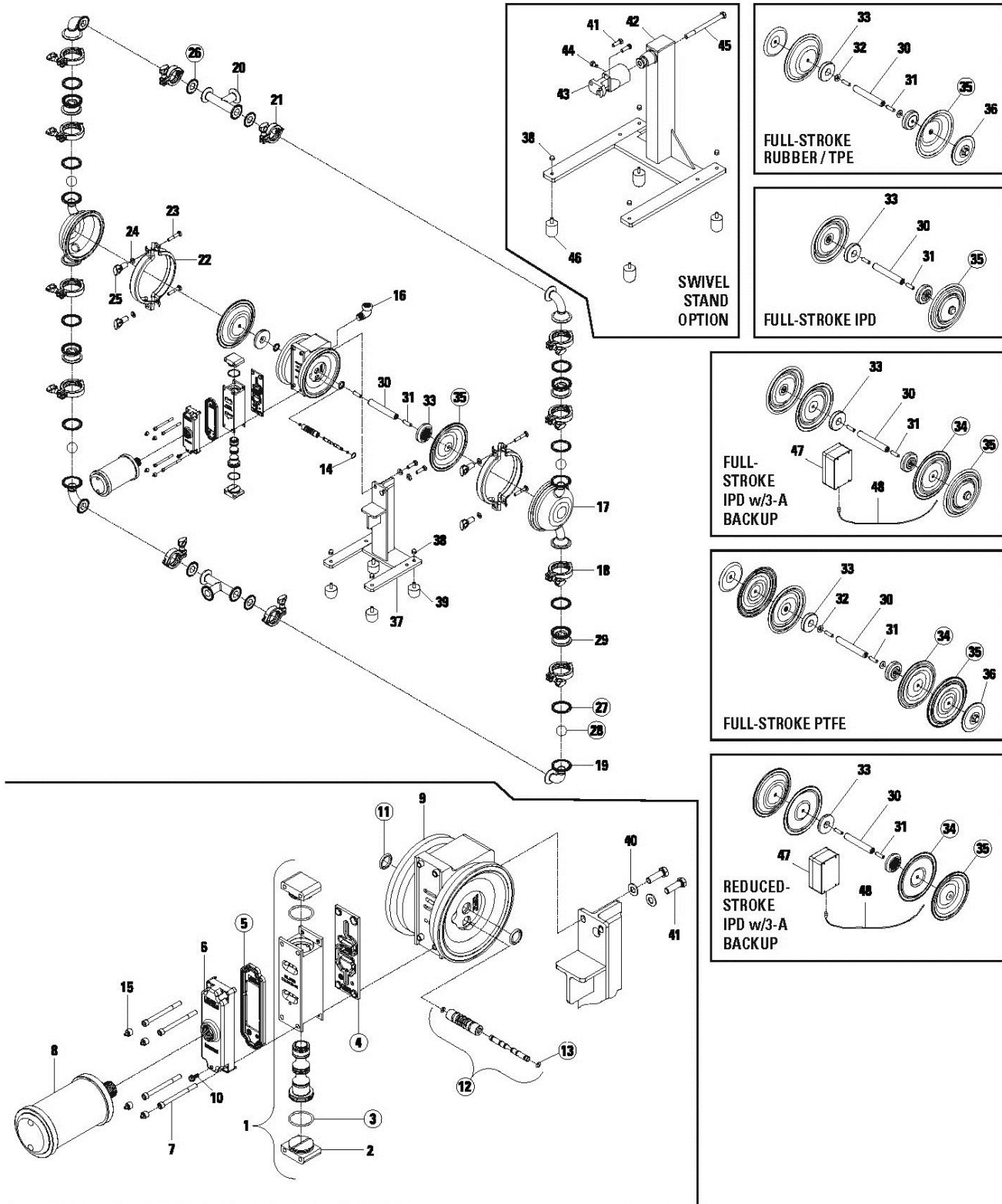

ALL CIRCLED PART IDENTIFIERS ARE INCLUDED IN REPAIR KITS.

LW0437, Rev. B

Exploded View and Parts List

Item	Description	Qty	XPS2 HS	XPS2 HS 3A
Air Distribution Components				
1	Air Valve, Pro-Flo X™ Assembly¹	1		02-2030-06
2	End Cap, Pro-Flo X®	2		01-2335-06
3	O-Ring, End Cap (-126) (ø1.362 X ø.103)	2		01-2395-52
4	Gasket, Air Valve, Pro-Flo X®	1		02-2620-52
5	Gasket, Muffler Plate, Pro-Flo X®	1		02-3502-52
6	Muffler Plate, Pro-Flo X®	1		02-3185-06
7	Screw, SHC, 1/4"-20 X 3"	4		01-6001-03
8	Muffler	1		08-3510-06R
9	Center Section Assembly, Pro-Flo SHIFT ²	1		02-3139-06
10	Screw, 10-32 X .50 Self-Tapping Grounding	1		04-6345-08
11	Shaft Seal	2		02-3210-55-225
12	Pilot Sleeve Assembly	1		02-3880-99
13	Pilot Spool Retaining O-Ring (ø.208 X ø.070)	2		04-2650-49-700
14	Retaining Ring	1		00-2650-03
15	Plug, 1/4" SHCS (3-A)	4		02-7825-17
16	Elbow, Street, 90° 1/2" NPT6	1		02-7843-03
Wetted Path Components				
▲ 17	Chamber, Liquid CIP 1" EHEDG	2		02-5002-10-385P
19	Clamp Band, Assy, Medium	8		02-7200-03-85
▲ 19	Elbow, 1" EHEDG	4		02-5240-10-385P
▲ 20	T-Section, 1" EHEDG	2		02-5160-10-385P
	T-Section, 1" EHEDG DIN	2	02-5160-10-386P	
	T-Section, 1" EHEDG SMS	2	02-5160-10-387P	
21	Clamp Band, Assy, Small	4		02-7100-03-85
22	Clamp Band Assy. Large ³	2		02-7300-03-385
23	Bolt, RHSN, 5/16"-18 X 2"	4		08-6050-03-500
24	Washer, (.344 I.D. X .688 O.D. X .065 THK.)	4		02-6731-03
25	Wing Nut, Medium Clamp	4		08-6661-10
Gaskets/Valve Balls				
▲ 26	Gasket, 1", Pkg 4	1		*
▲ 27	Gasket, 2", Pkg 2	4		*
▲ 28	Valve Ball, Pkg 4	1		*
Check Valve Components				
▲ 29	Ball Cage, 1" EHEDG	4		02-5350-10-385P
Full-Stroke Rubber/TPE/PTFE/FSIPD Components				
30	Shaft, P2 Pro-Flo™ (Non-PTFE)	1		02-3810-03
31	Shaft Stud, 3/8"-16 X 1-1/4"	2		02-6150-03-85
32	Spring, Disk	2	02-6802-08	
33	Piston, Inner, P2 Pro-Flo™ (Non-PTFE)	2		02-3701-01
34	Diaphragm, Full Stroke PTFE, Back-Up, Pkg 2	1	*	
	Diaphragm, Full Stroke IPD, Back-Up (3-A), Pkg 2	1		02-1061-55E
▲ 35	Diaphragm, Primary, Pkg 2	1	*	
	Diaphragm, Full Stroke PTFE, Primary, Pkg 2	1	02-1040-55E	
	Diaphragm, Full Stroke, IPD, Primary, Pkg 2	1	N/A	
▲ 36	Piston, Outer, (Non-PTFE)	2	02-4550-10-385P	

LW0439 Rev. C

*See Elastomer Chart.

▲ Product Contact Components.

¹Air Valve Assembly includes items 2 and 3.

²Center Section Assembly includes items 11.

³Large Clamp Band Assembly includes items 23, 24 and 25.

⁴Pump Stand Assembly includes items 38, 39, 40 and 41.

⁵Swivel Pump Stand Assembly includes items 38, 41, 43, 44, 45 and 46.

⁶Required for all 1" swivel stand models.

All boldface items are primary wear parts.

Exploded View and Parts List (Cont)

Item	Description	Qty	XPS2 HS	XPS2 HS 3A
Reduced-Stroke SIPD Components				
30	Shaft, Pro-Flo™ (PTFE)	1		02-3840-03
31	Shaft Stud, 3/8"-16 X 1-1/4"	2		02-6150-03-85
33	Piston, Inner, P2 Pro-Flo™ (PTFE)	2		02-3751-01
34	Diaphragm, Back-Up, IPD (3-A), Pkg 2	1		02-1060-55-85E
35	Diaphragm, Integral Piston, Pkg 2	1		02-1010-72-85E
Fixed Stand Components				
37	Stand, Pump, Assy. ⁴	1	02-7652-10-385	
38	Nut, Cap, 5/16"-18, Pump Stand	4		08-6600-03-72
39	Pad, Pump Stand	4	08-7670-20	
40	Washer, (.406 I.D. X .812 O.D. X .065 Thk.)	2	04-6740-03	
41	Screw, HHC, 3/8"-16 X 1-1/4"	2		04-6190-03
Swivel Stand Components				
42	Pump Stand, Swivel, Assy. ⁵ (3-A)	1		04-7655-03
43	Bushing, Center Block Mounting	1		15-7665-03
44	Locking Pin	1		08-7694-03
45	Screw, HHC, 1/2"-13 X 6"	1		15-6143-03
41	Screw, HHC, 3/8"-16 X 1-1/4"	2		04-6190-03
38	Nut, Cap, 5/16"-18, Pump Stand	4		08-6600-03-72
46	Pad, Pump Stand 2" (3-A)	4		08-7672-20
Accessory Components				
47	Control Module, Wil-Gard II, 110 (3-A)	1		65-8001-99
48	Sensor Cables, Wil-Gard II (3-A)	1		65-8020-99

LW0439 Rev. C

*See Elastomer Chart.

▲ Product Contact Components.

¹Air Valve Assembly includes items 2 and 3.

²Center Section Assembly includes items 11.

³Large Clamp Band Assembly includes items 23, 24 and 25.

⁴Pump Stand Assembly includes items 38, 39, 40 and 41.

⁵Swivel Pump Stand Assembly includes items 38, 41, 43, 44, 45 and 46.

⁶Required for all 1" swivel stand models.

All boldface items are primary wear parts.

Section 10

Elastomer Options

PS2 SANIFLOTM HS

Material	Diaphragms (2)	Full Stroke Diaphragms (2)	Full Stroke Back-Up Diaphragms (2)	Full Stroke IPD Diaphragms (2)	Full Stroke IPD Back-Up Diaphragms (2)	Valve Balls (4)	Gaskets, 1" (4)	Gaskets, 2" (8)
FDA Buna-N	02-1010-69					02-1086-69	02-1320-69-85	08-1375-69
FDA EPDM	02-1010-74					02-1086-74	02-1320-74-85	08-1375-74
Saniflex™	02-1010-56		02-1065-56	02-1031-56		02-1085-56		
PTFE	02-1010-72-85	02-1040-55			02-1061-55	02-1085-55	02-1320-55-85	08-1375-55
FDA Wil-Flex™	02-1010-57		02-1065-57	02-1031-57		02-1086-57		
FDA FKM							02-1320-68-85	02-1400-68-85

▲ Product Contact Components

LW0438 Rev. B

PS2 SANIFLOTM HS 1935/2004/EC

Material	Diaphragms (2)	Full Stroke Diaphragms (2)	Full Stroke Back-Up Diaphragms (2)	Full Stroke IPD Diaphragms (2)	Full Stroke IPD Back-Up Diaphragms (2)	Valve Balls (4)	Gaskets, 1" (4)	Gaskets, 2" (8)
FDA Buna-N	02-1010-69E					02-1086-69E	02-1320-69-85E	08-1375-69E
FDA EPDM	02-1010-74E					02-1086-74E	02-1320-74-85E	08-1375-74E
Saniflex™	02-1010-56E		02-1065-56E	02-1031-56E		02-1085-56E		
PTFE	02-1010-72-85E	02-1040-55E			02-1061-55E	02-1085-55E	02-1320-55-85E	08-1375-55E
FDA FKM							02-1320-68-85E	02-1400-68-85E

▲ Product Contact Components

LW0439 Rev. B

ISSUE DATE: June 22, 1995

CERTIFICATE AUTHORIZATION NUMBER: 833



THIS IS TO CERTIFY THAT

Wilden Pump & Engineering LLC

22069 Van Buren Street, Grand Terrace, CA 92313-5651

is hereby authorized to continue to apply the
3-A Symbol to the models of equipment, conforming to 3-A Sanitary Standards for:

Number 44-03
44-03 (Diaphragm Pumps)

set forth below

CIP Models: Models: PX, XPX, PS, XPS;
Sizes: 02, 04, 08, 15;
Wetted Housing: SZ;
Center / Air Valve: NNN, SSS;
Diaphragms: LEL, FWL, FSL;
Check Balls: FB, FE, FS, FW, TF;
Gaskets: FB, FE, FV, TF;
Leak Detection: 0774, 0775

VALID THROUGH: December 31, 2020

Timothy R. Rugh
Executive Director
3-A Sanitary Standards, Inc.

The issuance of this authorization for the use of the 3-A Symbol is based upon the voluntary certification, by the applicant for it, that the equipment listed above complies fully with the 3-A Sanitary Standard(s) designated. Legal responsibility for compliance is solely that of the holder of this Certificate of Authorization, and 3-A Sanitary Standards, Inc. does not warrant that the holder of an authorization at all times complies with the provisions of the said 3-A Sanitary Standards. This in no way affects the responsibility of 3-A Sanitary Standards, Inc. to take appropriate action in such cases in which evidence of nonconformance has been established.

NEXT TPV INSPECTION/REPORT DUE: March 2020

WILDEN®

DECLARATION OF CONFORMITY



PSG California LLC, 22069 Van Buren Street, Grand Terrace, CA 92313-5607 USA, certifies as the manufacturer that the Air-Operated Double Diaphragm pumps listed below comply with the following European Community Regulations:

- (EC) 1935/2004 for Food Contact Materials
- (EC) 2023/2006 Good Manufacturing Practice
- (EU) 10/2011 on plastic materials and articles intended to come in contact with food

- **25 mm (1") Saniflo Hygienic™ HS Metal Pump:**
(XPS,PS)2/(SS,SZ)(SSS,NNN)/(FBS,FES,FSL,FSS,LEL,TEU,TSS,TSU)/(FB,FE,FS,TF)/(FB,FE,FV,TF)/(0770-0789)E
- **38 mm – 76 mm (1-½"-3") Pro-Flo X Saniflo Hygienic™ HS Metal Pump:**
(PX,XPX)(4,8,15)/(SS,SZ)(SSS,NNN)(BNU,EPU,FBS,FES,FSL,FSS,LEL,TEU,TSS,TSU,ZSS)/(FB,FE,FS,FV,SF,TF,TFM)/(FB,FE,TF)/(0770-0789)E
- **38 mm – 76 mm (1-½"-3") Pro-Flo Shift Saniflo Hygienic™ HS Metal Pump:**
(PS,XPS)(4,8,15)/(SS,SZ)(SSS,NNN)/(FBS,FES,FSL,FSS,LEL,TSS,ZSS)/(FB,FE,FS,FV,SF,TF,TFM)/(FB,FE,TF)/(0770-0789)E
- **76 mm (3") Saniflo HS High Pressure Advanced Metal Pump**
H1500/(SS,SZ)III/(FSL,TSS)/(TF,TFM)/(FE,FV,TF)0770E
- **13 mm (½") Pro-Flo & Pro-Flo X™ Saniflo FDA Metal Pump Models:**
(P,PX,XPX)1/(SS,SZ)(AAA,GGG,JJJ,LLL,PPP)/(FSL,FSS,TEU,TSU)/(FS,TF)S/(FS,TF)/(0067,0070,0120)E
- **25 mm (1") Pro-Flo Saniflo FDA Metal Pump Models:**
P2/(SS,SZ)(LLL,PPP)/(FBS,FES,FSL,FSS,LEL,TEU,TSS,TSU)/(FS,TF)S/(FS,TF)2070E
- **38 mm (1-½") Pro-Flo & Pro-Flo X™ Saniflo FDA Metal Pump Models:**
(P,PX,XPX)4/(SS,SZ)(AAA,LLL,NNN,SSS)(BNU,EPU,FBS,FES,FSL,FSS,TEU,TSS,TSU)/(FS,TF)/(FS,STF)/(0067,0070,0075,0120)E
- **51 mm (2") Pro-Flo & Pro-Flo X™ Saniflo FDA Metal Pump Models:**
(P,PX,XPX)8/(SS,SZ)(AAA,PPP,NNN,SSS)(BNU,EPU,FBS,FES,FSS,TEU,TSU,TSS)/(FS,TF)/(FS,STF)/(0070,0075,0120)E
- **76 mm 3" Pro-Flo X™ Saniflo FDA Metal Pump Models:**
(PX,XPX)15/(SS,SZ)(AAA,NNN,SSS)(BNU,EPU,FSL,FSS,TEU,TSU,TSS)/(FS,TF)/(FS,STF)/(0070,0075,0120)E
- **38 mm 1-½" Pro-Flo Shift™ Saniflo FDA Metal Pump Models:**
XPS4/(SS,SZ)(AAA,NNN,SSS)/(FBS,FES,FSL,FSS,TSS,ZSS)/(FS,TF)/(FS,STF)/(0067,0070,0775,0120)E
- **51 mm 2" Pro-Flo Shift™ Saniflo FDA Metal Pump Models:**
XPS8/(SS,SZ)(AAA,NNN,SSS)/(FBS,FES,FSL,FSS,TSS,ZSS)/(FS,TF)/(FS,STF)/(0070,0075,0120)E
- **76 mm 3" Pro-Flo Shift™ Saniflo FDA Metal Pump Models:**
XPS15/(SS,SZ)(AAA,NNN,SSS)/(FSL,FSS,TSS,ZSS)/(FS,TF)/(FS,STF)/(0070,0120,0341)

Materials used in equipment that are intended to contact food belong to the groups of materials listed in Annex 1 (EC) 1935/2004 (List of groups of materials and articles which may be covered by specific measures)

- 5) Rubbers 8) Metal and Alloy 10) Plastics

Compliance is subject to material and equipment storage, handling and usage recommended by Wilden in the engineering operation and maintenance manual and supplemental technical publications.

This declaration is based on the following information:

- Statements of raw material from suppliers
- Total Migration Analysis per (EU) 10/2011

Wilden will make available to the competent authorities appropriate documentation to demonstrate compliance

Approved By:

Chris Distaso
Director of Engineering
Date: October 10, 2019



Notes

Notes

PSG
22069 Van Buren Street
Grand Terrace, CA 92313-5651 USA
P: +1 (909) 422-1730 • F: +1 (909) 783-3440
psgdover.com



Where Innovation Flows